



SCICHROLAB



Microbiology Filtration

BiFiL

Vacuum & Suction Solutions

Vacuum Pump

Focus on
laboratory sample filtration solutions

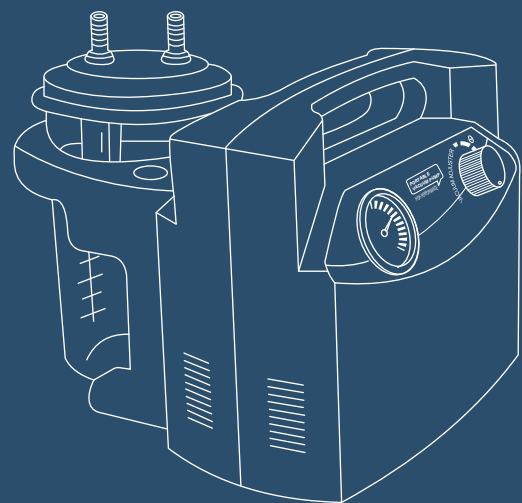
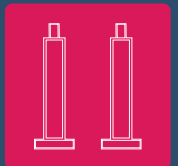

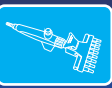

BIFIL VACUUM SUCTION PUMP WITH 1000ml waste liquid trap bottle

Feature

- **Maintenance-free**
100 % completely oil-free, dry running, non-polluting, No lubricant required, durable.
- **Overheat protection**
motor equipped with overheat protection when the temperature is over 100°, it stop automatically and start automatically after cooling.
- **Quiet, low vibration, high vacuum**
low vibration, compact inner constructional design, make the product work quiet.
- **Overflow protection**
waste liquid trap bottle built in spill-proof buoy to keep the filtrate from overflowing when waste liquid trap bottle is full.
- **Portability**
Compact design, space saving, easy to carry

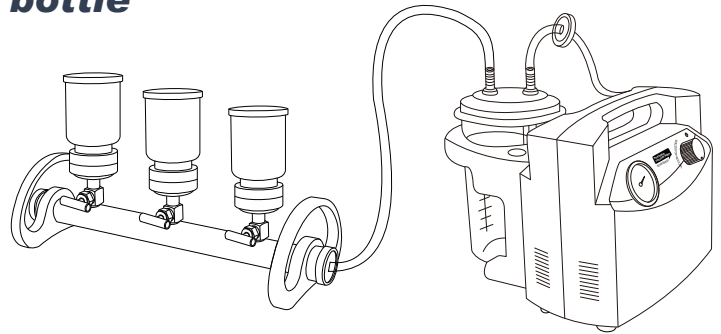

Main application

- **Vacuum filtration**
- **Microbial limited test**
- **Solid-phase extraction**

SPECIFICATION

1

GM12RE
167023-21

Vacuum Suction system
12 LPM



Model	GM12RE
Part.No.	167023-21
Max.flow rate	12 L.P.M
Extreme vacuum	≥0.085MPa
Vacuum adjustment	Yes
Motor power	60W
Voltage	220V/50Hz
Overheat protect	Yes
Drive type	Diaphragm
DB level	≤50dB
Inlet	φ 8mm
Liquid trap bottle	1000ml
Overflow protect	Yes
Air filter	PTFE-0.22
Dimension(mm)	220/285/195
Weight(Kg)	3

2

DT20RE
165973-32

Vacuum Suction system
20 LPM



Model	DT20RE
Part.No.	165973-32
Max.flow rate	20 L.P.M
Extreme vacuum	≥0.085MPa
Vacuum adjustment	Yes
Motor power	60W
Voltage	220V/50Hz
Overheat protect	Yes
Drive type	Piston
DB level	≤50dB
Inlet	φ 8mm
Liquid trap bottle	1000ml
Overflow protect	Yes
Air filter	PTFE-0.22
Dimension(mm)	220/285/195
Weight(Kg)	3



BIFIL VACUUM SUCTION SYSTEM

With 1000ml waste liquid trap bottle
With inkfish SC10 suction kits

Feature

- **Maintenance-free**
100 % completely oil-free, dry running, non-polluting, No lubricant required, durable.
- **Overflow protection**
waste liquid trap bottle built in spill-proof buoy to keep the filtrate from overflowing when waste liquid trap bottle is full.
- **Overheat protection**
motor equipped with overheat protection when the temperature is over 100°, it stop automatically and start automatically after cooling.
- **Portability**
Compact design, space saving, easy to carry
- **Quiet, low vibration, high vacuum**
low vibration, compact inner constructional design, make the product work quiet.
- **Inkfish suction kits**
Single-handed tip ejection, Quick fitting change, Autoclavable



Main application

- Cell culture aspiration
- Laboratory waste suction

SPECIFICATION

Model	GM12SP
Part.No.	167024-31
Max.flow rate	12 L.P.M
Extreme vacuum	≥0.085MPa
Vacuum adjustment	Yes
Motor power	60W
Voltage	220V/50Hz
Overheat protect	Yes
Drive type	Diaphragm
DB level	≤50dB
Inlet	ø 8mm
Liquid trap bottle	1000ml
Overflow protect	Yes
Air filter	PTFE-0.22
Dimension(mm)	220/285/195
Weight(Kg)	3
Suction component	
Inkfish suction kits	POM/SS/PP

3

GM12SP
167024-31

Vacuum Suction system
12 LPM



4

DT20SP
165973-42

Vacuum Suction system
20 LPM



Model	GM20SP
Part.No.	165973-42
Max.flow rate	20 L.P.M
Extreme vacuum	≥0.085MPa
Vacuum adjustment	Yes
Motor power	60W
Voltage	220V/50Hz
Overheat protect	Yes
Drive type	Piston
DB level	≤50dB
Inlet	ø 8mm
Liquid trap bottle	1000ml
Overflow protect	Yes
Air filter	PTFE-0.22
Dimension(mm)	220/285/195
Weight(Kg)	3
Suction component	
Inkfish suction kits	POM/SS/PP



BIFIL INKFISH SUCTION KITS

With 1-channel tips connector
With 8-channel tips connector



Feature

- 8-channel tip ejection**
 The innovative tip ejection design enables tip ejection by single hand easy.
- Quick fitting change**
 Quick connection coupling between fitting and handle can make any fittings replaced quickly.
- Autoclavable**
 The complete kit are made of POM and stainless steel material available for autoclave.



Model	Inkfish
Part.No.	16210F-36
Handle	POM/SS
1-channel tip adaptor	POM
8-channel tips adaptor	POM
8-channel tips ejector	POM
SS needle	SS/PP
Inlets	ø 8 mm
Autoclave	121°

Key function 1

1 -channel tip mode

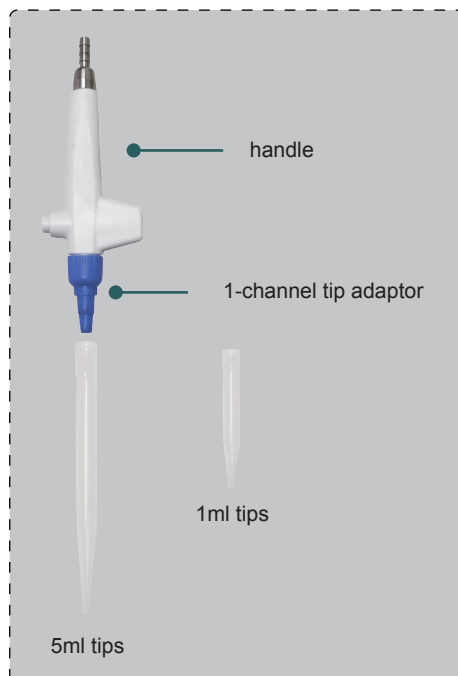

Key function 2

8 -channel tip mode

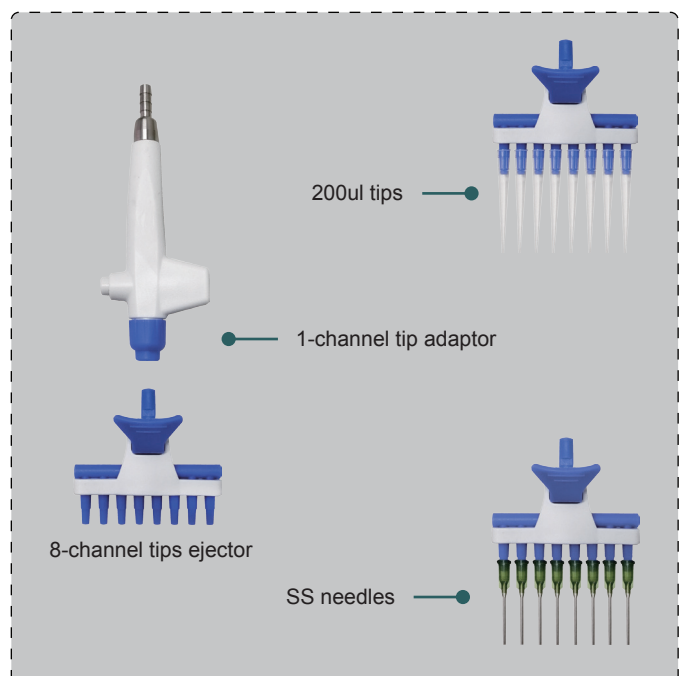



ACCESSORIES

Waste liquid trap bottle VF10



- VF10 Waste liquid trap bottle built in spill-proof buoy to keep the filtrate from overflowing when bottle is full.

Model	VF10
Part.No.	16100F-25
Capacity	1000 ml
Graduated increment	100 ml
Inlet & Outlet (I.D. tube)	ø 8 mm
Spill-proof buoy	Yes
Container	PC
Cover	PC

Waste liquid trap bottle TF10



- TF10 Waste liquid trap bottle is consist of GL45 solvent bottle with special cap & stopper.

Model	TF10
Part.No.	668026-10
Capacity	1000 ml
Inlet & Outlet (I.D. tube)	ø 8 mm
Container	GL45 solvent bottle
Cap	PP
Stoppor	Silicone

Air Filter F22PT



- Air filter is a disc filter which effectively prevent aqueous liquid into vacuum pump. It built in hydrophobic PTFE membrane.

Model	F22PT
Part.No.	15350B-05
housing material	PP
O.D. housing	51 mm
Membrane material	Hydrophobic PTFE
Core size	0.22 um
Inlet & Outlet (I.D. tube)	ø 6-10mm

VREZ

Filtration & Separation Solutions

Filtration Manifold

Focus on
laboratory sample filtration solutions

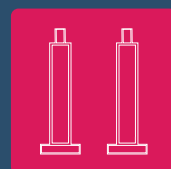
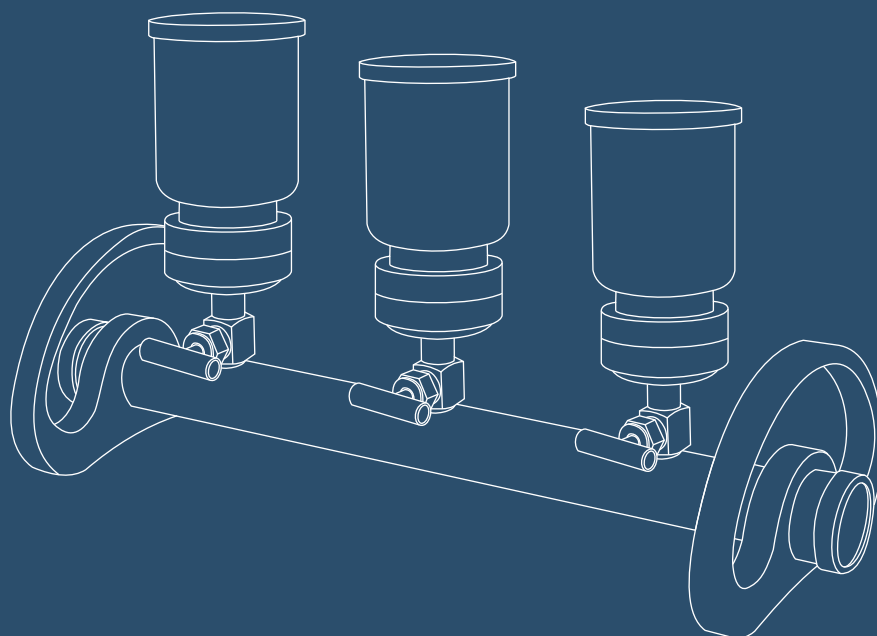



FILTRATION MANIFOLD

Enjoy the Laboratory

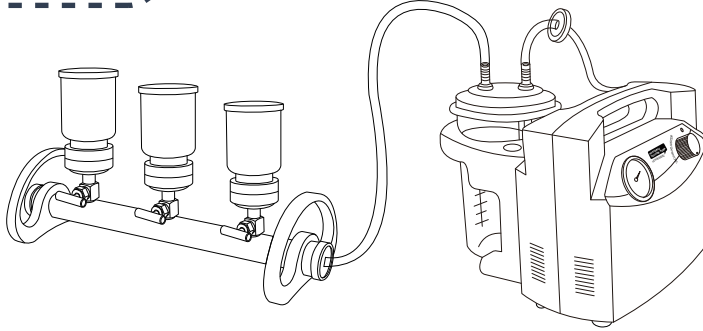

GUIDANCE

1. choose a suitable manifold rack



2. choose a suitable filtration holder

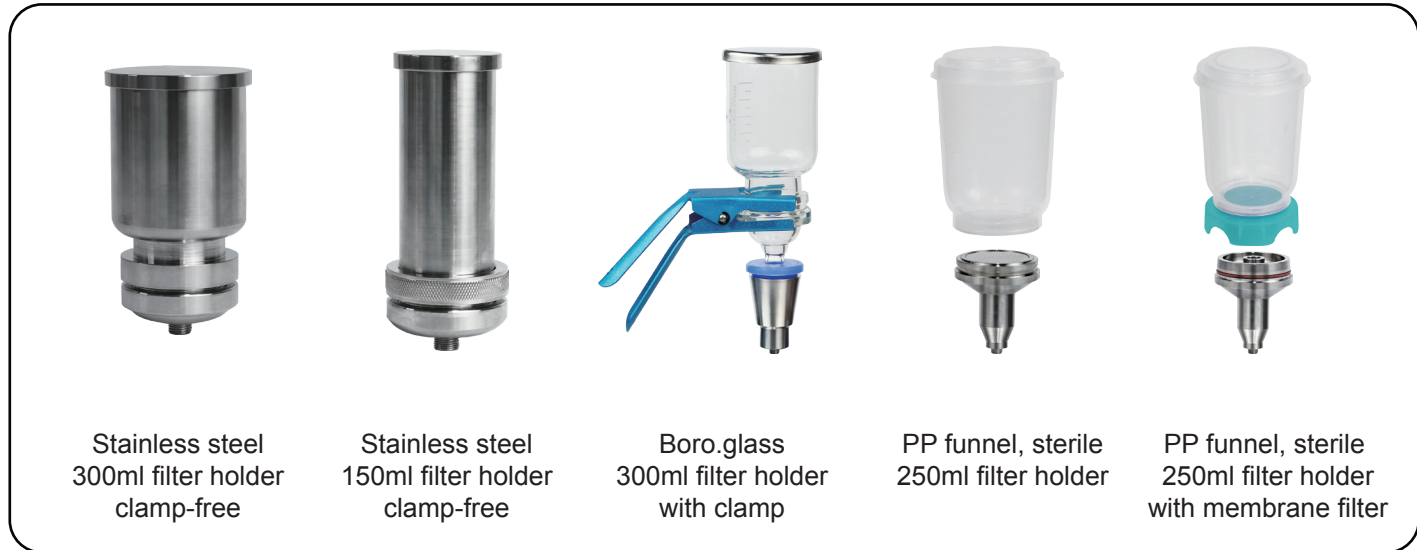



FEATURE

Main parts is made of SUS316

Each parts can be simple and rapidly assembled, which offer excellent chemical resistance and can be fastly sterilized by flame, steam, oven etc..

Individual control valve

Each funnel valve can be independently controlled.

Compatible to different size of holder

Manifold Branch Ports are available to fit 150ml, 300ml, 250ml, 300ml holders.

Meet various laboratory need



PRODUCT INFORMATION

Filtration manifold with 300ml SS holder

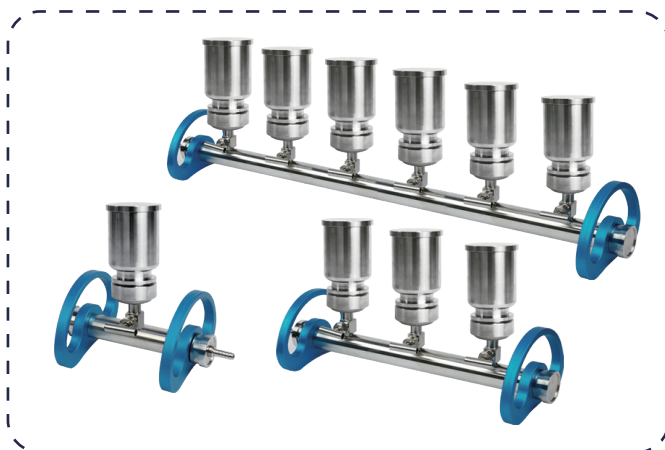

SPECIFICATION

Item	VREZ-1CF	VREZ-3CF	VREZ-6CF
Part.No.	267102-71	267303-72	267603-73
Branch number	1 Port	3 Ports	6 Ports
Holder number	1 Set	3 Sets	6 Sets
Funnel volume	300ml	300ml	300ml
Filter diameter	47-50mm	47-50mm	47-50mm
outlet	ø 8 mm	ø 8 mm	ø 8 mm
Parts	Material	Material	Material
Rack	SUS316	SUS316	SUS316
Handle	Anodized Alum.	Anodized Alum.	Anodized Alum.
Funnel & Lid	SUS316	SUS316	SUS316
Funnel support base	SUS316	SUS316	SUS316

Filtration manifold with 150ml SS holder

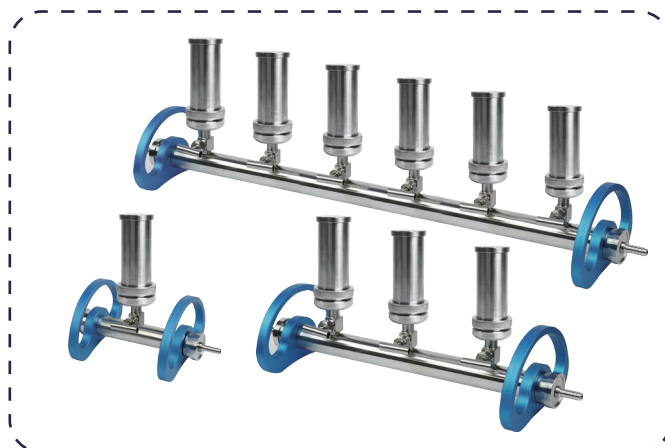

SPECIFICATION

Item	VREZ-1DF	VREZ-3DF	VREZ-6DF
Part.No.	267104-81	267304-82	267604-83
Branch number	1 Port	3 Ports	6 Ports
Holder number	1 Set	3 Sets	6 Sets
Funnel volume	150ml	150ml	150ml
Filter diameter	47-50mm	47-50mm	47-50mm
outlet	ø 8 mm	ø 8 mm	ø 8 mm
Parts	Material	Material	Material
Rack	SUS316	SUS316	SUS316
Handle	Anodized Alum.	Anodized Alum.	Anodized Alum.
Funnel & Lid	SUS316	SUS316	SUS316
Funnel support base	SUS316	SUS316	SUS316



Filtration manifold with 300ml Boro.glass holder

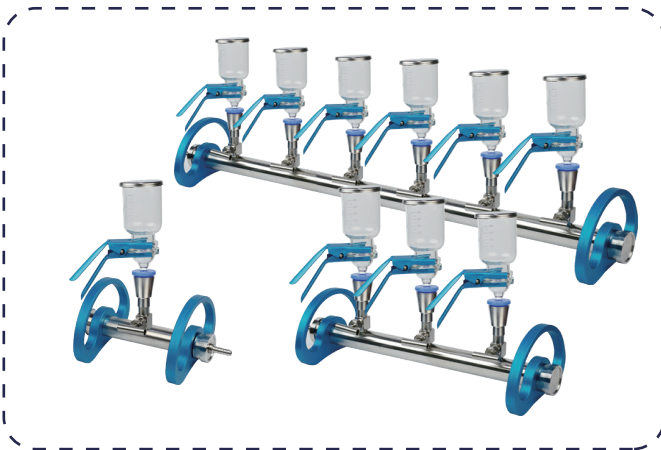

SPECIFICATION

Item	VREZ-1AF	VREZ-3AF	VREZ-6AF
Part.No.	267100-51	267300-52	267600-53
Branch number	1 Port	3 Ports	6 Ports
Holder number	1 Set	3 Sets	6 Sets
Funnel volume	300ml	300ml	300ml
Filter diameter	47-50mm	47-50mm	47-50mm
outlet	ø 8 mm	ø 8 mm	ø 8 mm
Parts	Material	Material	Material
Rack	SUS316	SUS316	SUS316
Handle	SUS316	SUS316	SUS316
Funnel & Lid	Boro.glass / SS	Boro.glass / SS	Boro.glass / SS
Funnel support base	Boro.glass PTFE gasket SS screen Silicone stopper	Boro.glass PTFE gasket SS screen Silicone stopper	Boro.glass PTFE gasket SS screen Silicone stopper

Filtration manifold Fit 250ml sterile funnel

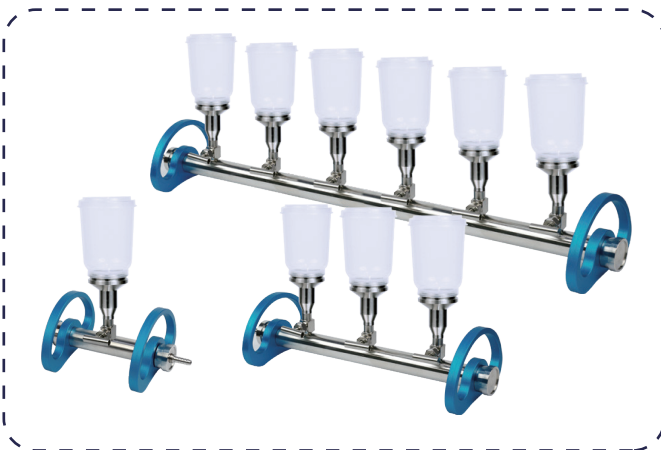

SPECIFICATION

Item	VREZ-1EF	VREZ-3EF	VREZ-6EF
Part.No.	278105-10	278305-11	278605-12
Branch number	1 Port	3 Ports	6 Ports
Holder number	1 Set	3 Sets	6 Sets
Filter diameter	47-50mm	47-50mm	47-50mm
outlet	ø 8 mm	ø 8 mm	ø 8 mm
Parts	Material	Material	Material
Rack	SUS316	SUS316	SUS316
Handle	Anodized Alum.	Anodized Alum.	Anodized Alum.
Funnel support base	SUS316	SUS316	SUS316
Holder (Optional)	Single-pack	Single-pack	Single-pack
Funnel & Lid	PP	PP	PP
Funnel volume	250ml	250ml	250ml
Sterile	EtO	EtO	EtO

Filtration manifold Fit 250ml sterile holder

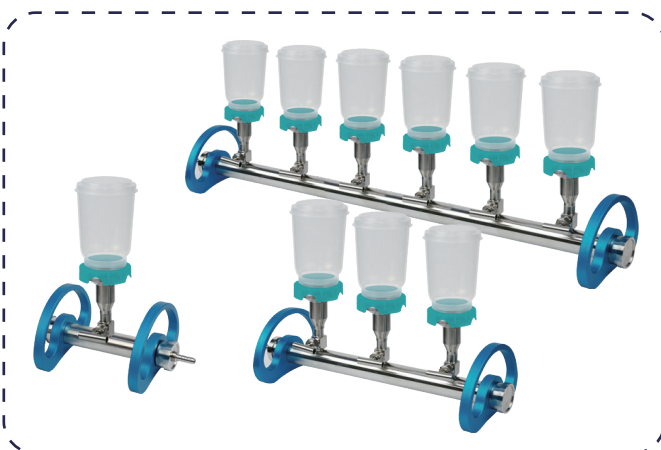

SPECIFICATION

Item	VREZ-1HF	VREZ-3HF	VREZ-6HF
Part.No.	278106-21	278306-22	278606-23
Branch number	1 Port	3 Ports	6 Ports
Holder number	1 Set	3 Sets	6 Sets
Filter diameter	47-50mm	47-50mm	47-50mm
outlet	ø 8 mm	ø 8 mm	ø 8 mm
Parts	Material	Material	Material
Rack	SUS316	SUS316	SUS316
Handle	Anodized Alum.	Anodized Alum.	Anodized Alum.
Holder base	SUS316	SUS316	SUS316
Holder (Optional)	Single-pack	Single-pack	Single-pack
Funnel & Lid	PP	PP	PP
Funnel support base	PP	PP	PP
Funnel volume	250ml	250ml	250ml
Sterile	EtO	EtO	EtO

VREZ

Filtration & Separation Solutions

Stream filtration system

Focus on
laboratory sample filtration solutions

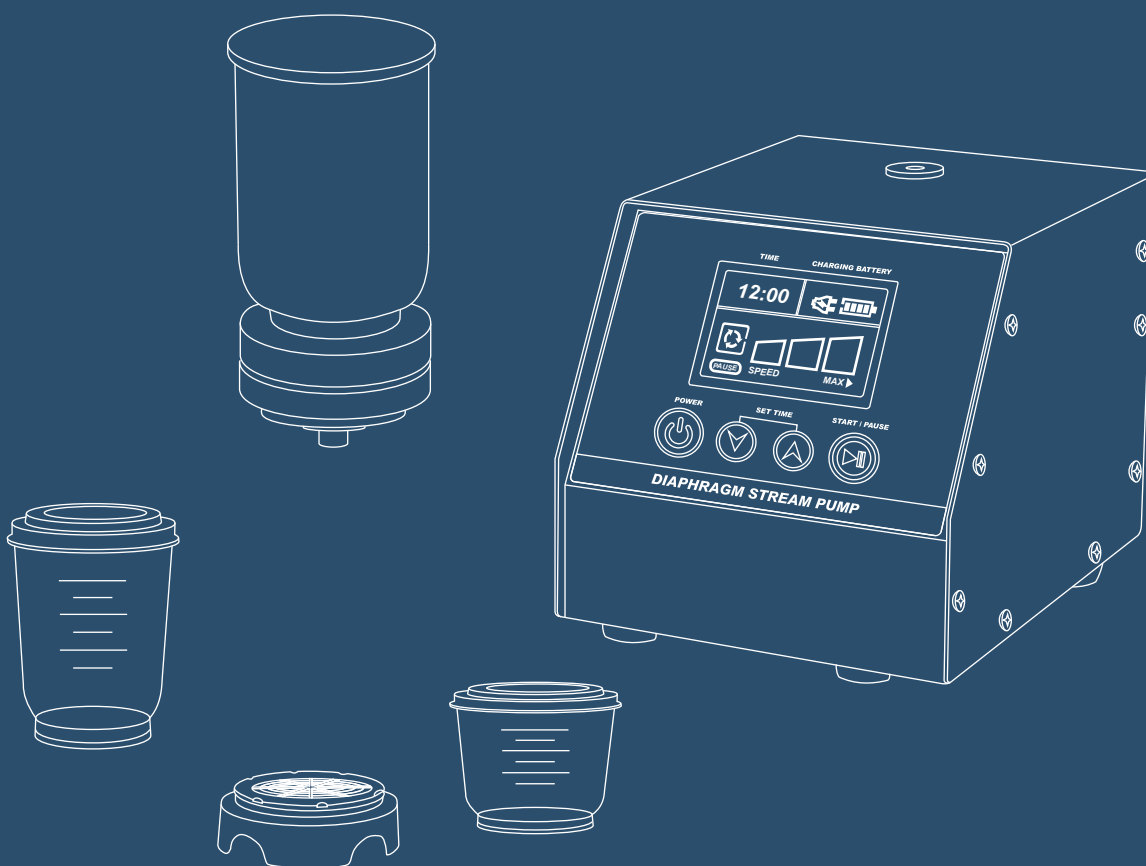
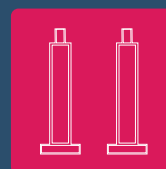
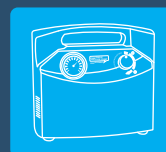



STREAM FILTRATION SYSTEM

Enjoy the Laboratory

ALL in ONE

WHAT IS STREAM FILTRATION SYSTEM ?

DO YOU NEED IT?



Stainless steel
150ml filter holder
clamp-free



Stainless steel
300ml filter holder
clamp-free



Boro.glass
300ml filter holder
with clamp

Meet various laboratory need



PP funnel, sterile
250ml filter holder



PP funnel, sterile
250ml filter holder
with membrane filter



Inkfish suction kits



Filtration manifold



FEATURE

Save Space, Save time

No need of suction flask and waste bottle saving much bench, No need of taking time to empty waste bottle.

Easy Operation

Simply put on membrane on filter holder and touch control panel to start filtration easily, support adjust control rate. LCD display screen can easy identify.

Compatible to different size of holder

Manifold Branch Ports are available to fit 150ml, 300ml, 250ml, 300ml holders, suction kits, and filtration manifold.

Safety

No worry about waste liquid being sucked into pump

Build-in rechargeable battery

Stream pump build in 5200mA large volume battery, available for outdoor sampling. No longer limited by wires.



SPECIFICATION

Item	WV300
Part.No.	579300-10
Drive type	Diaphragm
Flow rate control	Three-speed gear
Max. flow rate(water)	1500ml /min
Display screen	LED
Key Control	Touch panel
Voltage	12.6V
Built-in battery capacity	5200mA
Charger	12.6V/3A
Outlet	ø 5mm/ c 8mm
Dimension(mm)	200X135X135mm
Weight(Kg)	1.8Kg
House material	SUS304
Panel	PMMA

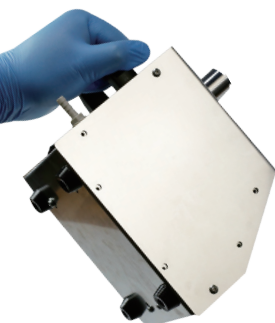

**Battery
usage**



**Plug in
usage**

PRODUCT INFORMATION

Fit stainless steel funnel holder



VREZ-F8
Stainless steel
150ml filter holder
clamp-free

+

WV300
Stream pump

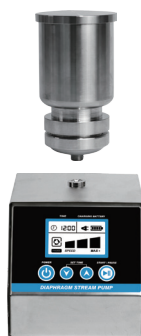

VREZ-F7
Stainless steel
150ml filter holder
clamp-free

+

WV300
Stream pump





Fit Boro.glass funnel holder



VREZ-F6
Boro.glass
300ml filter holder
with clamp

+

WV300
Stream pump

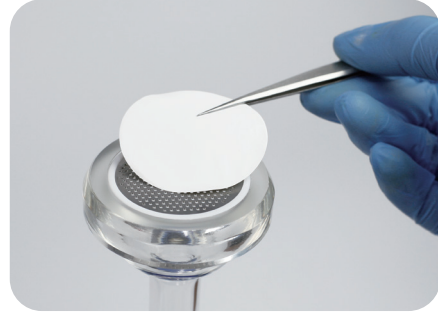

Fit sterile PP funnel holder



PP funnel, sterile
250ml filter holder

+

WV300
Stream pump



PP funnel, sterile
250ml filter holder
with membrane filter

+

WV300
Stream pump



Membrane filter
can be cultivated directly

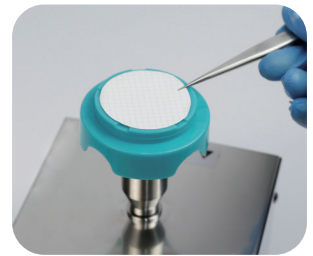

Fit Inkfish suction kits



Inkfish SC10
suction kits

+

WV300
Stream pump

Fit filtration manifold



Filtration manifold
VREZ-3CF

+

WV300
Stream pump



Phone: +86 188 2709 1392

Email: chemicals_trading@126.com

Address: Rm 305, Building Tengjundebiyiyuan,
No.1658 Gumei Road, Xuhui District, Shanghai