



SCICHROLAB



Oil-Free Vacuum Pump

BiFiL

Vacuum & Suction Solutions

Vacuum Pump

Focus on
laboratory sample filtration solutions

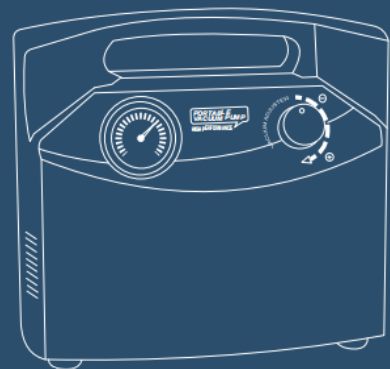
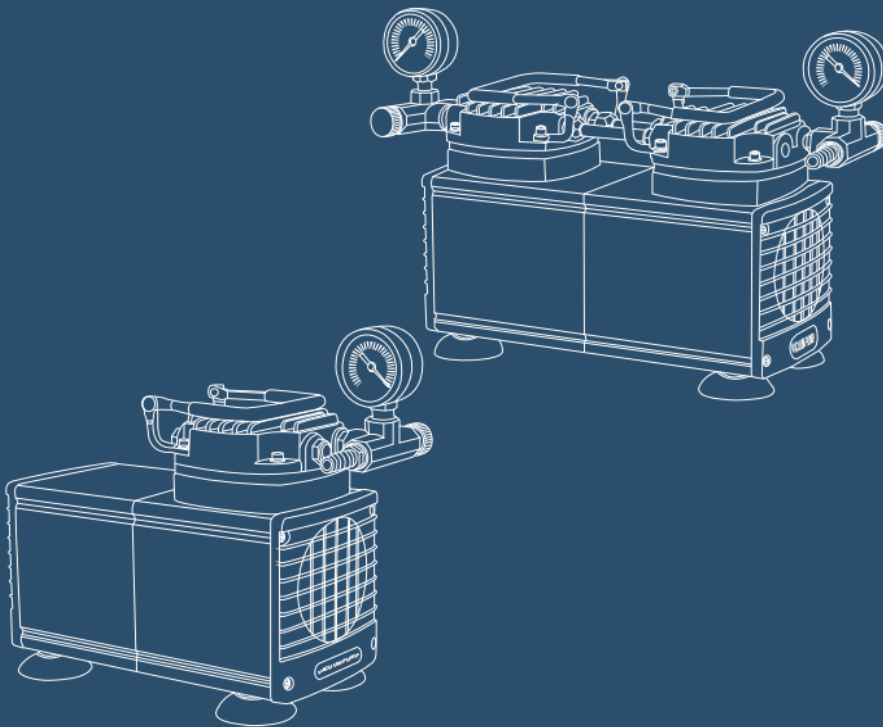
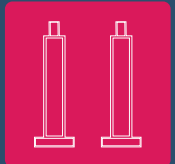



BIFIL Laboratory Oil-Free Vacuum Pump

Experience the joy of silent portability in the laboratory setting.

The product operates continuously without the need for oil, featuring a compact size, low noise, high efficiency, and a long service life. It comes standard with a vacuum gauge and a pressure regulator to facilitate vacuum adjustment. It is pollution-free and maintenance-free. A variety of power options are available, making it suitable for laboratory applications such as vacuum filtration, solvent evaporation, solid-phase extraction, gel drying, cell culture, and air sampling. The oil-free characteristic provides an economical and portable vacuum solution, widely applied in various settings including suction, filtration, washing, and vacuum drying.



HIGHLIGHTS

01 Aluminum Pump Housing

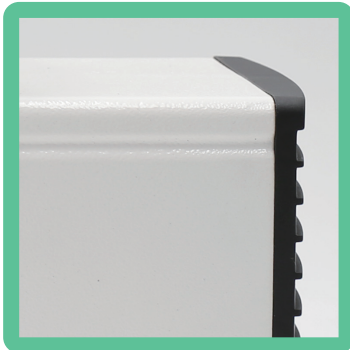

02 Compact Design



03 Integrated Adjustment Module



Highlight Interpretation





BIFIL VACUUM PUMP

In the development process, we underwent several experiments and refinements, which resulted in an increased air extraction capacity while minimizing noise to the lowest levels. We have compared our improved final product with other similar products on the market and are highly satisfied with the outcome.

-  VACUUM FILTRATION
-  AIR SAMPLING
-  SOLVENT PURIFICATION
-  COLLOID DRYING
-  BIOCHEMICAL SUCTION
-  SOLID-PHASE EXTRACTION
-  VACUUM DRYING

1

NV25A
150025-10

25 LPM Oil-Free Vacuum Pump



Oil-Free and Maintenance-Free

Non-polluting, maintenance-free, utilizing piston motion that does not require oil lubrication, thus eliminating the need for regular oil top-ups and preventing issues with oil contamination.

Integrated Overheat Protection

Each motor is equipped with an overheat protection device, which automatically shuts down the unit when the internal temperature becomes excessively high. It will then restart once the temperature has cooled down.

High flow rate, high vacuum, compact size

High-flow design with a smaller footprint compared to similar products, featuring direct-drive motors that eliminate the need for belt lubrication, ensuring quiet operation and reduced vibration.

2

PN25
150125-20

25 LPM Oil-Free Vacuum Pump (With positive pressure functionality)



Specification Parameters

Model type	NV25A	PN25
Product Number	150025-10	150125-20
Maximum Airflow Rate	25 L.P.M	25 L.P.M
Ultimate Vacuum Level	≥0.085MPa	≥0.085MPa
Stress	-	≥60Psi
Authenticity Adjustment	Yes	Yes
Motor Power	160W	160W
Voltage	220V/50Hz	220V/50Hz
Revolutions per minute (rpm)	1450-1700	1450-1700
Acoustic Disturbance	≤50dB	≤50dB
Standard Intake Port	ϕ 8mm	ϕ 8mm
Dimensions (mm)	195/100/160	195/100/160
Weight (Kg)	3.5	3.5



IT MAY BE

Standard equipment in your laboratory

The practicality and portability of the product have been our ultimate goals for a long time. We believe this product will earn your trust and become your most reliable assistant.

BIFIL VACUUM PUMP Optimal Filtration Drying Vacuum Equipment

3

NV40B
150040-10

40 LPM Oil-Free Vacuum Pump



-  Vacuum filtration
-  Solvent purification
-  Biochemical suction
-  Vacuum drying
-  Atmospheric sampling
-  Colloid drying
-  Solid-phase extraction

4

PN40
150140-20

40 LPM Oil-Free Vacuum Pump (With positive pressure functionality)



Specification Parameters

Model type	NV40B	PN40
Product Number	150040-10	150140-20
Maximum Airflow Rate	40 L.P.M	40 L.P.M
Ultimate Vacuum Level	≥0.085MPa	≥0.085MPa
Stress	-	≥80Psi
Authenticity Adjustment	Yes	Yes
Motor Power	250W	250W
Voltage	220V/50Hz	220V/50Hz
Revolutions per minute (rpm)	1850-2100	1850-2100
Acoustic Disturbance	≤50dB	≤50dB
Standard Intake Port	ϕ 8mm	ϕ 8mm
Dimensions (mm)	240/100/160mm	240/100/160mm
Weight (Kg)	5.5Kg	5.5Kg



BIFIL VACUUM PUMP

Enjoy the Laboratory

Feature

- **Maintenance-free**
100 % completely oil-free, dry running, non-polluting, No lubricant required, durable.
- **Overheat protection**
motor equipped with overheat protection when the temperature is over 100C, it stop automatically and start automatically after cooling.
- **Quiet, low vibration, high vacuum**
low vibration, compact inner constructional design, make the product work quiet.

Main application

- **Vacuum filtration**
- **Solvent purification**
- **Air sampling**
- **Solid-phase extraction**

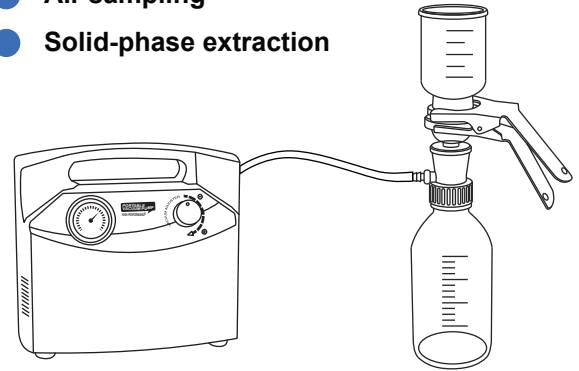

1

GM12
167022-11

Diaphragm vacuum pump
12 LPM



SPECIFICATION

Model	GM12
Part.No.	167022-11
Max.flow rate	12 L.P.M
Extreme vacuum	≥0.085 MPa
Vacuum adjustment	Yes
Motor power	60W
Voltage	220V/50Hz
Overheat protect	Yes
Drive type	Diaphragm
Inlet	ϕ 8 mm
Dimension(mm)	220/130/195 mm
Weight(Kg)	2.2 Kg

2

DT20
165973-22

Piston vacuum pump
20 LPM



Model	DT20
Part.No.	165973-22
Max.flow rate	20 L.P.M
Extreme vacuum	≥0.085 MPa
Vacuum adjustment	Yes
Motor power	60W
Voltage	220V/50Hz
Overheat protect	Yes
Drive type	Piston
Inlet	ϕ 8 mm
Dimension(mm)	220/130/195 mm
Weight(Kg)	2.2 Kg

Focus on
laboratory sample filtration solutions

SCIDISC

Sample Filtration & Separation

Membrane filters

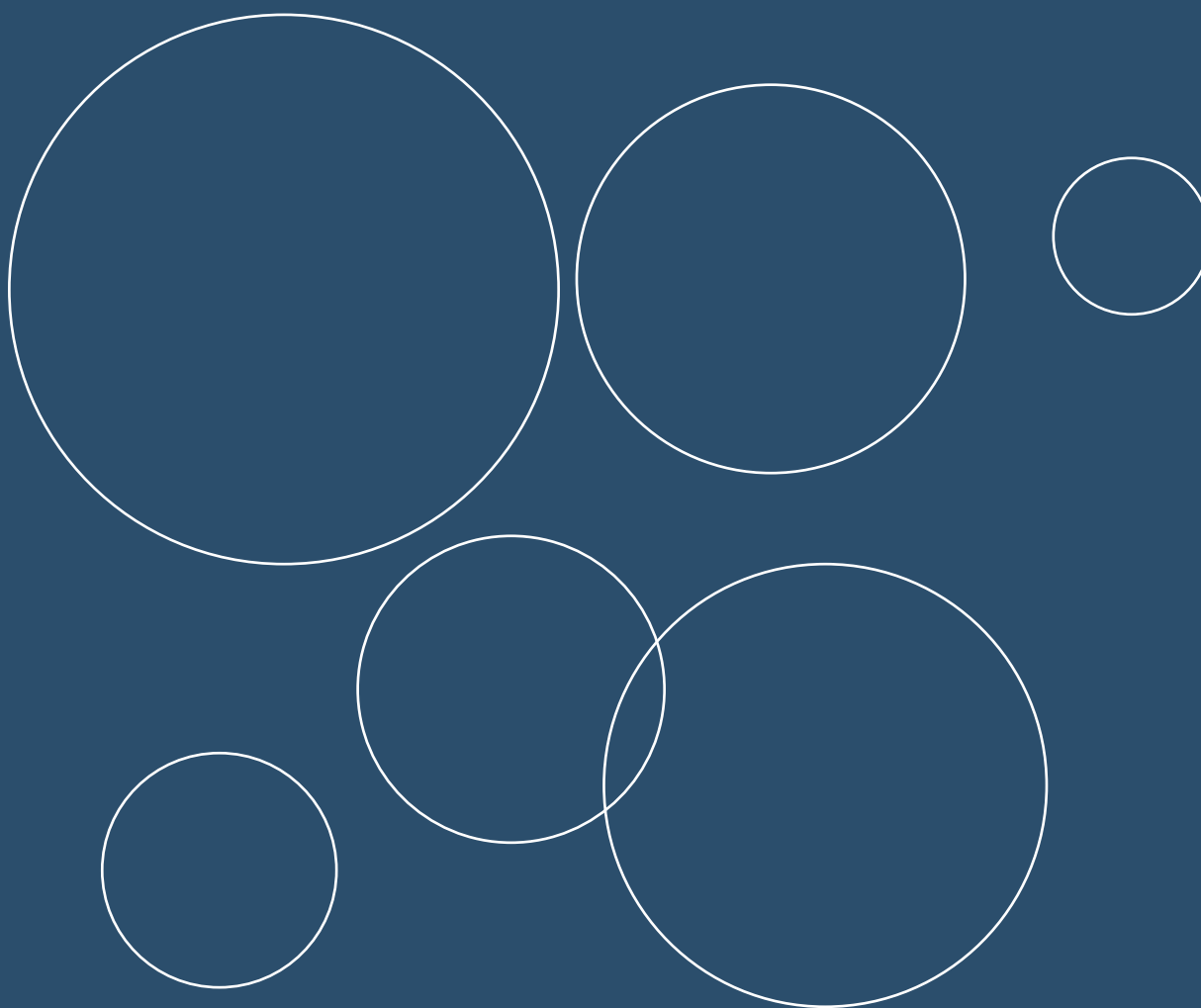



**Satisfied any requires of
Filtration process in Laboratory**

Ensures good experimental accuracy with widely application in Pharmaceutical, Environmental, Biological, Food analysis, Agricultural test.

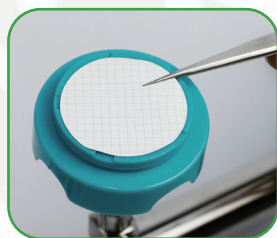

SCIDISC series Membrane filters

Membrane	Application
Mixed Cellulose Esters (MCE)	<ul style="list-style-type: none"> Dissolves Completely Using Standard Digestion Procedures. Cleans completely, possesses low artifacts, and offers minimal interference in fiber counting. Ideal for Aqueous Solutions. Low Protein Retention. 0.22µm for Fluid Sterilization. Naturally Hydrophilic.
Polyethersulfone (PES)	<ul style="list-style-type: none"> Ideal for use in Life Science Applications to Remove Particulates During General Filtration. Low Protein and Drug Binding Characteristics.
Nylon (NY)	<ul style="list-style-type: none"> Ideal for use in General Filtration or Medical Assays & HPLC Sample Preparation. High Protein Binding Capacity: Immobilizes Antigens, Antibodies & other Proteins. Naturally Hydrophilic.

BH Polypropylene (BHP)	<ul style="list-style-type: none"> HPLC Sample Prep Requiring Low Detection Levels. Aqueous & Organic Solvent Filtration. Ion Chromatography. Naturally Hydrophilic.
Polytetrafluoroethylene (PTFE)	<ul style="list-style-type: none"> Filtration of Strong Acids & Aggressive Solvents. Venting Applications. Phase Separations. Strong Hydrophobicity.
Polyvinylidene Fluoride (PVDF)	<ul style="list-style-type: none"> Sterilizing Filtration of Biological Solutions. Clarifying Filtration of Biological Solutions. Provides High Flow Rates & Throughput. Low Extractability & Broad Chemical Compatibility. Hydrophobic.
Glass Fiber (GF)	<ul style="list-style-type: none"> Use as a Pre-filter to Extend Membrane Life. Water & Air Pollution Analysis. Liquid Clarification.

Order Information

MCE

Item number	Description	Item number	Description
M13MC-022	13mm, 0.22µm, 100/pk	M60MC-022	60mm, 0.22µm, 100/pk
M13MC-045	13mm, 0.45µm, 100/pk	M60MC-045	60mm, 0.45µm, 100/pk
M13MC-080	13mm, 0.8µm, 100/pk	M60MC-080	60mm, 0.8µm, 100/pk
M25MC-022	25mm, 0.22µm, 100/pk	M70MC-022	70mm, 0.22µm, 100/pk
M25MC-045	25mm, 0.45µm, 100/pk	M70MC-045	70mm, 0.45µm, 100/pk
M25MC-080	25mm, 0.8µm, 100/pk	M70MC-080	70mm, 0.8µm, 100/pk
M47MC-022	47mm, 0.22µm, 50/pk	M90MC-022	90mm, 0.22µm, 100/pk
M47MC-045	47mm, 0.45µm, 50/pk	M90MC-045	90mm, 0.45µm, 100/pk
M47MC-080	47mm, 0.8µm, 50/pk	M90MC-080	90mm, 0.8µm, 100/pk
M50MC-022	50mm, 0.22µm, 50/pk	M100MC-022	100mm, 0.22µm, 100/pk
M50MC-045	50mm, 0.45µm, 50/pk	M100MC-045	100mm, 0.45µm, 100/pk
M50MC-080	50mm, 0.8µm, 50/pk	M100MC-080	100mm, 0.8µm, 100/pk

PES

Item number	Description	Item number	Description
M13ES-022	13mm, 0.22µm , 100/pk	M60ES-022	60mm, 0.22µm , 50/pk
M13ES-045	13mm, 0.45µm , 100/pk	M60ES-045	60mm, 0.45µm , 50/pk
M13ES-080	13mm, 0.8µm , 100/pk	M60ES-080	60mm, 0.8µm , 50/pk
M25ES-022	25mm, 0.22µm , 100/pk	M70ES-022	70mm, 0.22µm , 50/pk
M25ES-045	25mm, 0.45µm , 100/pk	M70ES-045	70mm, 0.45µm , 50/pk
M25ES-080	25mm, 0.8µm , 100/pk	M70ES-080	70mm, 0.8µm , 50/pk
M47ES-022	47mm, 0.22µm , 50/pk	M90ES-022	90mm, 0.22µm , 50/pk
M47ES-045	47mm, 0.45µm , 50/pk	M90ES-045	90mm, 0.45µm , 50/pk
M47ES-080	47mm, 0.8µm , 50/pk	M90ES-080	90mm, 0.8µm , 50/pk
M50ES-022	50mm, 0.22µm , 50/pk	M100ES-022	100mm, 0.22µm , 50/pk
M50ES-045	50mm, 0.45µm , 50/pk	M100ES-045	100mm, 0.45µm , 50/pk
M50ES-080	50mm, 0.8µm , 50/pk	M100ES-080	100mm, 0.8µm , 50/pk

NY66

Item number	Description	Item number	Description
M13NY-022	13mm, 0.22µm , 100/pk	M60NY-022	60mm, 0.22µm , 50/pk
M13NY-045	13mm, 0.45µm , 100/pk	M60NY-045	60mm, 0.45µm , 50/pk
M13NY-080	13mm, 0.8µm , 100/pk	M60NY-080	60mm, 0.8µm , 50/pk
M25NY-022	25mm, 0.22µm , 100/pk	M70NY-022	70mm, 0.22µm , 50/pk
M25NY-045	25mm, 0.45µm , 100/pk	M70NY-045	70mm, 0.45µm , 50/pk
M25NY-080	25mm, 0.8µm , 100/pk	M70NY-080	70mm, 0.8µm , 50/pk
M47NY-022	47mm, 0.22µm , 50/pk	M90NY-022	90mm, 0.22µm , 50/pk
M47NY-045	47mm, 0.45µm , 50/pk	M90NY-045	90mm, 0.45µm , 50/pk
M47NY-080	47mm, 0.8µm , 50/pk	M90NY-080	90mm, 0.8µm , 50/pk
M50NY-022	50mm, 0.22µm , 50/pk	M100NY-022	100mm, 0.22µm , 50/pk
M50NY-045	50mm, 0.45µm , 50/pk	M100NY-045	100mm, 0.45µm , 50/pk
M50NY-080	50mm, 0.8µm , 50/pk	M100NY-080	100mm, 0.8µm , 50/pk

PTFE

Hydrophilic

Item number	Description	Item number	Description
M13PT-022	13mm, 0.22µm , 100/pk	M60PT-022	60mm, 0.22µm , 50/pk
M13PT-045	13mm, 0.45µm , 100/pk	M60PT-045	60mm, 0.45µm , 50/pk
M25PT-022	25mm, 0.22µm , 100/pk	M70PT-022	70mm, 0.22µm , 50/pk
M25PT-045	25mm, 0.45µm , 100/pk	M70PT-045	70mm, 0.45µm , 50/pk
M47PT-022	47mm, 0.22µm , 50/pk	M90PT-022	90mm, 0.22µm , 50/pk
M47PT-045	47mm, 0.45µm , 50/pk	M90PT-045	90mm, 0.45µm , 50/pk
M50PT-022	50mm, 0.22µm , 50/pk	M100PT-022	100mm, 0.22µm , 50/pk
M50PT-045	50mm, 0.45µm , 50/pk	M100PT-045	100mm, 0.45µm , 50/pk

PVDF

Hydrophilic

Item number	Description	Item number	Description
M13PV-022	13mm, 0.22µm , 100/pk	M60PV-022	60mm, 0.22µm , 50/pk
M13PV-045	13mm, 0.45µm , 100/pk	M60PV-045	60mm, 0.45µm , 50/pk
M25PV-022	25mm, 0.22µm , 100/pk	M70PV-022	70mm, 0.22µm , 50/pk
M25PV-045	25mm, 0.45µm , 100/pk	M70PV-045	70mm, 0.45µm , 50/pk
M47PV-022	47mm, 0.22µm , 50/pk	M90PV-022	90mm, 0.22µm , 50/pk
M47PV-045	47mm, 0.45µm , 50/pk	M90PV-045	90mm, 0.45µm , 50/pk
M50PV-022	50mm, 0.22µm , 50/pk	M100PV-022	100mm, 0.22µm , 50/pk
M50PV-045	50mm, 0.45µm , 50/pk	M100PV-045	100mm, 0.45µm , 50/pk

BHP

Item number	Description	Item number	Description
M13BH-022	13mm, 0.22µm , 100/pk	M60BH-022	60mm, 0.22µm , 50/pk
M13BH-045	13mm, 0.45µm , 100/pk	M60BH-045	60mm, 0.45µm , 50/pk
M25BH-022	25mm, 0.22µm , 100/pk	M70BH-022	70mm, 0.22µm , 50/pk
M25BH-045	25mm, 0.45µm , 100/pk	M70BH-045	70mm, 0.45µm , 50/pk
M47BH-022	47mm, 0.22µm , 50/pk	M90BH-022	90mm, 0.22µm , 50/pk
M47BH-045	47mm, 0.45µm , 50/pk	M90BH-045	90mm, 0.45µm , 50/pk
M50BH-022	50mm, 0.22µm , 50/pk	M100BH-022	100mm, 0.22µm , 50/pk
M50BH-045	50mm, 0.45µm , 50/pk	M100BH-045	100mm, 0.45µm , 50/pk



GF

Item number	Description	Item number	Description
M13GF-045	13mm, 0.45µm , 100/pk	M60GF-045	60mm, 0.45µm , 25/pk
M13GF-080	13mm, 0.8µm , 100/pk	M60GF-080	60mm, 0.8µm , 25/pk
M25GF-045	25mm, 0.45µm , 50/pk	M70GF-045	70mm, 0.45µm , 25/pk
M25GF-080	25mm, 0.8µm , 50/pk	M70GF-080	70mm, 0.8µm , 25/pk
M47GF-045	47mm, 0.45µm , 25/pk	M90GF-045	90mm, 0.45µm , 25/pk
M47GF-080	47mm, 0.8µm , 25/pk	M90GF-080	90mm, 0.8µm , 25/pk
M50GF-045	50mm, 0.45µm , 25/pk	M100GF-045	100mm, 0.45µm , 25/pk
M50GF-080	50mm, 0.8µm , 25/pk	M100GF-080	100mm, 0.8µm , 25/pk

* Customize diameter of 120mm, 135mm, 142mm, 150mm, 200mm

* **HYDROPHILIC**
Water accepting or wetting.

* **HYDROPHOBIC**
A membrane or other material which repels and cannot be wetted by aqueous and other high surface tension fluids. When pre-wetted with low surface tension fluid, such as alcohol, the filter will then wet with water.

Sterile Membrane filters

MCE WHITE / PLAIN

Single-pack , ETO(Ethylene oxide)

Ideal for microbiological test of aqueous solution, large throughout, fast filtration are applicable to water sample and other easily filtered samples of microorganisms Inspection ,also can be used for liquid micro particle removal and biological load reduction.

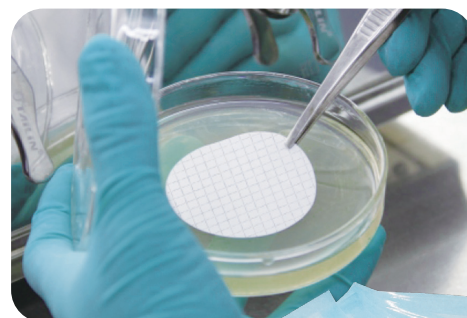

MCE WHITE / GRID

Single-pack , ETO(Ethylene oxide)

Ideal for microbiological test of aqueous solution, large throughout, fast filtration are applicable to water sample and other easily filtered samples of microorganisms Inspection ,also can be used for liquid micro particle removal and biological load reduction. Grid provide guidance for observation and counting analysis.

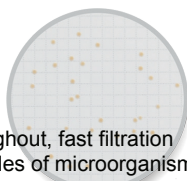

MCE BLACK / GRID

Single-pack , ETO(Ethylene oxide)

Ideal for microbiological test of aqueous solution, Dark background provides excellent contrast for counting opaque colonies in microbiology labs. Unique grid pattern gridline provides guidance for quantification of bacterial colonies without growth inhibition or enhance-ment. Sharp contrast between black membrane and white grid line provides guidance while viewing and counting.

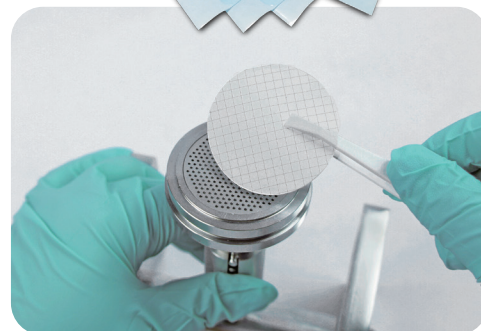

Order Information

	Item number	Description	Sterile	Item number	Description	Sterile
MCE White / Plain	ETM47-WN022	47mm, 0.22µm , 100/pk	EtO	ETM50-WN022	50mm, 0.22µm , 100/pk	EtO
	ETM47-WN045	47mm, 0.45µm , 100/pk	EtO	ETM50-WN045	50mm, 0.45µm , 100/pk	EtO
	ETM47-WN080	47mm, 0.8µm , 100/pk	EtO	ETM50-WN080	50mm, 0.8µm , 100/pk	EtO
MCE White / Grid	ETM47-WG022	47mm, 0.22µm , 100/pk	EtO	ETM50-WG022	50mm, 0.22µm , 100/pk	EtO
	ETM47-WG045	47mm, 0.45µm , 100/pk	EtO	ETM50-WG045	50mm, 0.45µm , 100/pk	EtO
MCE Black / Grid	ETM47-BG022	47mm, 0.22µm , 100/pk	EtO	ETM50-BG022	50mm, 0.22µm , 100/pk	EtO
	ETM47-BG045	47mm, 0.45µm , 100/pk	EtO	ETM50-BG045	50mm, 0.45µm , 100/pk	EtO

* Customize Nylon66, PES, PVDF single-pack sterile membrane filter

Focus on
laboratory sample filtration solutions

SCIDISC

Sample Filtration & Separation

Syringe Filter

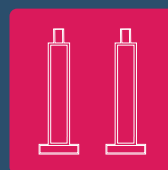

Design

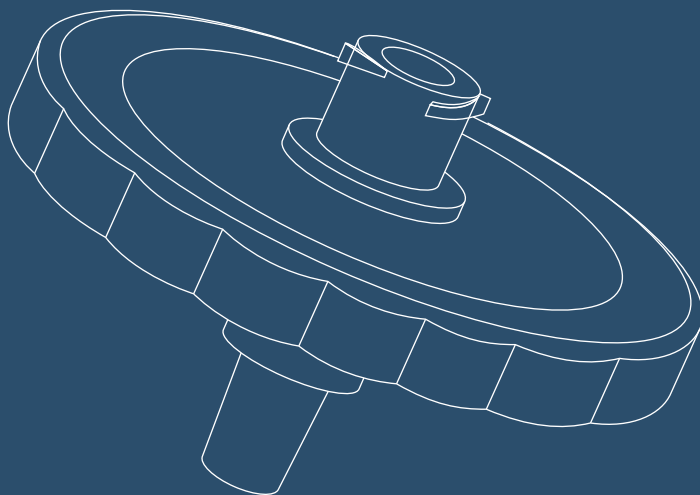
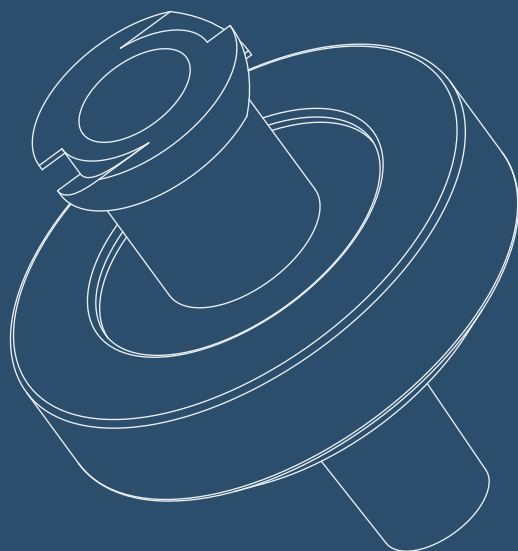

Manufacture



- ⊙ **High throughputs**
- ⊙ **Low dissolution**

Satisfied any requires of Filtration process in Laboratory

Ensures good experimental accuracy with widely application in Pharmaceutical, Environmental, Biological, Food analysis, Agricultural test.

100%
satisfied
guarantee



SCIDISC series Syringe Filter

Technical Specification

- Diameter: 13mm and 25mm
- Pore Size:
0.22µm, 0.45µm, 0.80µm, 1.0µm, 5µm and others
- Membrane Materials:
MCE, Nylon, PTFE, PES, PVDF, BHP, GF
- Housing Material: Polypropylene
Color: Polypropylene
- Connections:
Luer-Lock (Female Connection) and Luer-Lock or Slip (Male Connection)
- Effective filtration area:
13mm: 1 cm² 25mm: 2.8 cm²
- Processing volume:
13mm: 1-10ml 25mm: 10-50ml
- Typical residues:
13mm: <28µl 25mm: <70µl

HYDROPHILIC
Water accepting or wetting.

HYDROPHOBIC
A membrane or other material which repels and cannot be wetted by aqueous and other high surface tension fluids. When pre-wetted with low surface tension fluid, such as alcohol, the filter will then wet with water.

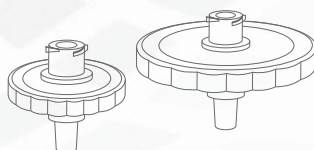

Membrane	Application
Mixed Cellulose Esters (MCE)	<ul style="list-style-type: none"> • Dissolves Completely Using Standard Digestion Procedures. • Cleans completely, possesses low artifacts, and offers minimal interference in fiber counting. • Ideal for Aqueous Solutions. • Low Protein Retention. • 0.22µm for Fluid Sterilization. • Naturally Hydrophilic.
Polyethersulfone (PES)	<ul style="list-style-type: none"> • Ideal for use in Life Science Applications to Remove Particulates During General Filtration. • Low Protein and Drug Binding Characteristics.
Nylon (NY)	<ul style="list-style-type: none"> • Ideal for use in General Filtration or Medical Assays & HPLC Sample Preparation. • High Protein Binding Capacity: Immobilizes Antigens, Antibodies & other Proteins. • Naturally Hydrophilic.
BH Polypropylene (BHP)	<ul style="list-style-type: none"> • HPLC Sample Prep Requiring Low Detection Levels. • Aqueous & Organic Solvent Filtration. • Ion Chromatography. • Naturally Hydrophilic.
Polytetrafluoroethylene (PTFE)	<ul style="list-style-type: none"> • Filtration of Strong Acids & Aggressive Solvents. • Venting Applications. • Phase Separations. • Strong Hydrophobicity.
Polyvinylidene Fluoride (PVDF)	<ul style="list-style-type: none"> • Sterilizing Filtration of Biological Solutions. • Clarifying Filtration of Biological Solutions. • Provides High Flow Rates & Throughput. • Low Extractability & Broad Chemical Compatibility. • Hydrophobic.
Glass Fiber (GF)	<ul style="list-style-type: none"> • Use as a Pre-filter to Extend Membrane Life. • Water & Air Pollution Analysis. • Liquid Clarification.



AQUEOUS SOLUTION



MCE SYRINGE FITLER

Naturally hydrophilic , can meet the need of Aqueous sample clarification

MCE

Item number	Description	Color	UOM
S13MC-022	13mm, 0.22µm , non-sterile	Green	100pk
S13MC-045	13mm, 0.45µm , non-sterile	Blue	
S13MC-080	13mm, 0.8µm , non-sterile	Violet	
S25MC-022	25mm, 0.22µm , non-sterile	Green	
S25MC-045	25mm, 0.45µm , non-sterile	Blue	
S25MC-080	25mm, 0.8µm , non-sterile	Pink	
ETS13MC-022	13mm, 0.22µm , sterile	Green	90pk
ETS13MC-045	13mm, 0.45µm , sterile	Blue	
ETS13MC-080	13mm, 0.8µm , sterile	Violet	
ETS25MC-022	25mm, 0.22µm , sterile	Green	50pk
ETS25MC-045	25mm, 0.45µm , sterile	Blue	
ETS25MC-080	25mm, 0.8µm , sterile	Pink	

PES SYRINGE FITLER

Fast filtration with superior flow rates and high throughputs,Low protein binding and extensive drug compatibility for critical applications

PES

Item number	Description	Color	UOM
S13ES-022	13mm, 0.22µm , non-sterile	Aqua	100pk
S13ES-045	13mm, 0.45µm , non-sterile	skyblue	
S13ES-080	13mm, 0.8µm , non-sterile	Lightorange	
S25ES-022	25mm, 0.22µm , non-sterile	Aqua	
S25ES-045	25mm, 0.45µm , non-sterile	skyblue	
S25ES-080	25mm, 0.8µm , non-sterile	Lightorange	
ETS13ES-022	13mm, 0.22µm , sterile	Aqua	90pk
ETS13ES-045	13mm, 0.45µm , sterile	skyblue	
ETS13ES-080	13mm, 0.8µm , sterile	Lightorange	
ETS25ES-022	25mm, 0.22µm , sterile	Aqua	50pk
ETS25ES-045	25mm, 0.45µm , sterile	skyblue	
ETS25ES-080	25mm, 0.8µm , sterile	Lightorange	

GF SYRINGE FITLER

Glass fiber media provide utility in a variety of life sciences applications requiring efficient clarification of aqueous-based solutions.

GF

Item number	Description	Color	UOM
S13GF-045	13mm, 0.45µm , non-sterile	Seagreen	100pk
S13GF-080	13mm, 0.8µm , non-sterile	Maize	
S25GF-045	25mm, 0.45µm , non-sterile	Seagreen	
S25GF-080	25mm, 0.8µm , non-sterile	Maize	
ETS13GF-045	13mm, 0.45µm , sterile	Seagreen	90pk
ETS13GF-080	13mm, 0.8µm , sterile	Maize	
ETS25GF-045	25mm, 0.45µm , sterile	Seagreen	50pk
ETS25GF-080	25mm, 0.8µm , sterile	Maize	



ORGANIC SOLUTION



NYLON66 SYRINGE FITLER

Excellent chemical compatibility with esters, bases, and alcohols, Naturally hydrophilic, Useful for a wide range of applications. Offers broad chemical resistance to common solvents.

NY66

Item number	Description	Color	UOM
S13NY-022	13mm, 0.22µm , non-sterile	Yellow	100pk
S13NY-045	13mm, 0.45µm , non-sterile	White	
S13NY-080	13mm, 0.8µm , non-sterile	Orange	
S25NY-022	25mm, 0.22µm , non-sterile	Yellow	
S25NY-045	25mm, 0.45µm , non-sterile	White	
S25NY-080	25mm, 0.8µm , non-sterile	Orange	
ETS13NY-022	13mm, 0.22µm , sterile	Yellow	90pk
ETS13NY-045	13mm, 0.45µm , sterile	White	
ETS13NY-080	13mm, 0.8µm , sterile	Orange	
ETS25NY-022	25mm, 0.22µm , sterile	Yellow	50pk
ETS25NY-045	25mm, 0.45µm , sterile	White	
ETS25NY-080	25mm, 0.8µm , sterile	Orange	

BHP SYRINGE FITLER

Provide high particle retention, high dirt holding capacity and low pressure drop. it is designed for filtration of organic solvents , also for the filtration of aqueous solutions.

BHP

Item number	Description	Color	UOM
S13BH-022	13mm, 0.22µm , non-sterile	Magenta	100pk
S13BH-045	13mm, 0.45µm , non-sterile	Purple	
S25BH-022	25mm, 0.22µm , non-sterile	Magenta	
S25BH-045	25mm, 0.45µm , non-sterile	Purple	
ETS13BH-022	13mm, 0.22µm , sterile	Magenta	90pk
ETS13BH-045	13mm, 0.45µm , sterile	Purple	
ETS25BH-022	25mm, 0.22µm , sterile	Magenta	50pk
ETS25BH-045	25mm, 0.45µm , sterile	Purple	

PTFE SYRINGE FITLER

Strong Chemically Resistant Membranes for Sampling in Aggressive Environments, Ideal for filtration of organic solvents. Hydrophobic for Aggressive Environments, Ideal for venting and gas filtration .

PTFE
Hydrophilic
Hydrophobic

Item number	Description	Color	UOM
S13PT-022	Hydrophilic	13mm, 0.22µm , non-sterile	100pk
S13PT-045		13mm, 0.45µm , non-sterile	
S25PT-022		25mm, 0.22µm , non-sterile	
S25PT-045		25mm, 0.45µm , non-sterile	
S13PT-022B	Hydrophobic	13mm, 0.22µm , non-sterile	100pk
S13PT-045B		13mm, 0.45µm , non-sterile	
S25PT-022B		25mm, 0.22µm , non-sterile	
S25PT-045B		25mm, 0.45µm , non-sterile	
ETS13PT-022	Hydrophilic	13mm, 0.22µm , sterile	90pk
ETS13PT-045		13mm, 0.45µm , sterile	
ETS25PT-022		25mm, 0.22µm , sterile	50pk
ETS25PT-045		25mm, 0.45µm , sterile	



AQUEOUS & ORGANIC SOLUTION

PVDF SYRINGE FITLER

Useful for a wide range of applications including aggressive and non-aggressive solvent-based samples



PVDF

Hydrophilic

Item number	Description	Color	UOM
S13PV-022	13mm, 0.22µm , non-sterile	Orange	100pk
S13PV-045	13mm, 0.45µm , non-sterile	Pink	
S25PV-022	25mm, 0.22µm , non-sterile	Orange	
S25PV-045	25mm, 0.45µm , non-sterile	Pink	
ETS13PV-022	13mm, 0.22µm , sterile	Orange	90pk
ETS13PV-045	13mm, 0.45µm , sterile	Pink	50pk
ETS25PV-022	25mm, 0.22µm , sterile	Orange	
ETS25PV-045	25mm, 0.45µm , sterile	Pink	

STERILE SYRINGE FILTER

Medical grade package

The packing of sterile syringe filter is made of medical grade PVC and Aluminum materials. Both sterilization performance and safety condition are secured.

ETO(Ethylene oxide)

ETO(Ethylene oxide) is one of best sterilization reagent, its capable of removal of all kinds of Microbiological features such as bacterial spore. ETO has very strong penetrability during sterilization process, which fits medical level of packing materials, ETO is very good choice in terms of product such as syringe filter which does not work on high - Temp or high humid condition.

Single-pack

The packing method ensures easy usage (just break through PTP film). PVC material does not contain softening agent, Non-toxic and Non-polluting, with long-life storage.

Color distinction membrane

The transparent packing is used for product distinguish, each syringe filter has its own featured color with corresponding specification, customers can pick up what suits their the best by selecting colors.



Enhances your selection of OEM requires

We are capable of customized products according to our customer's require: specification, packing, imaging etc. We offer our customer's best solution for their desired product with our strong production facility and high level of designing.

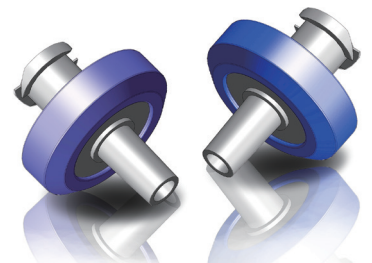

Supply of OEM products with flexibility



SS FILTER

SS-HOUSING SYRINGE FILTER

- Lightweight design, flexible, easy to clean
- Easy to operate, silicone-ring sealing
- Corrosion resistant, autoclave at 121°
- Specially suitable for plasticizer samples



Specification

Housing : SUS316 Screen support: SUS316 sealing : Silicone-ring

Product Information



Item	SF13	SF25	SF50
Part.No.	420513-25	420523-26	420533-27
membrane diameter(mm)	13	25	50
UOM package(ea/pk)	1	1	1

Q&A How to choose ?

STEP 1 : CHOOSE THE SUITABLE MEMBRANE FILTRATION MEDIA?

Characteristics of samples

Aqueous

MCE
PES
NYLON

No Polar

NYLON
PTFE
PVDF

Protein

PES
PVDF

STEP 2 : CHOOSE THE SUITABLE DIAMETER?

Volume of samples

1-10ml

13mm

10-50ml

25mm

over 50ml

50mm

STEP 3 : CHOOSE THE SUITABLE PORE SIZE?

Micron size of column

< 3um

0.22µm

> 3um

0.45µm

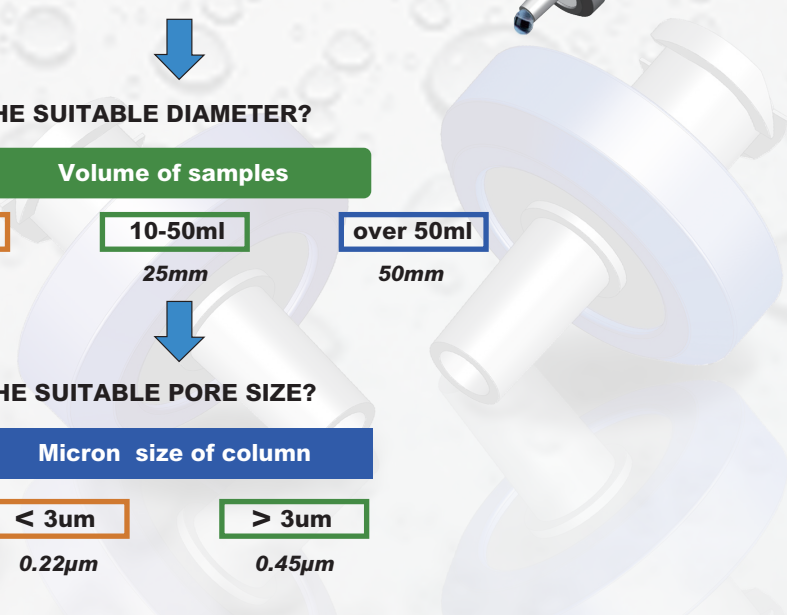

SOFIA

Membrane Filtration Solutions

Laboratory Filtration

Focus on
laboratory sample filtration solutions

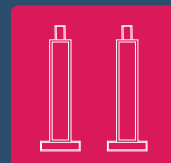



STORAGE BOTTLE FILTRATION SETS

47mm / 50mm

Feature

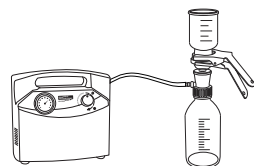

- Unique filtration adaptor design can be directly connect with GL45 storage bottle, and replace any GL45 thread of various specifications of the storage bottle.
- After purification of solvents can be directly used for filtration of mobile phase in HPLC analysis, without the need of being transferred from the filtering flask.
- Adopt high quality borosilicate glass with good pressure resistance
- Filtration adaptor and PP funnel can be Acid and alkali resistance, also autoclavable at 121°C



HF10

RF10

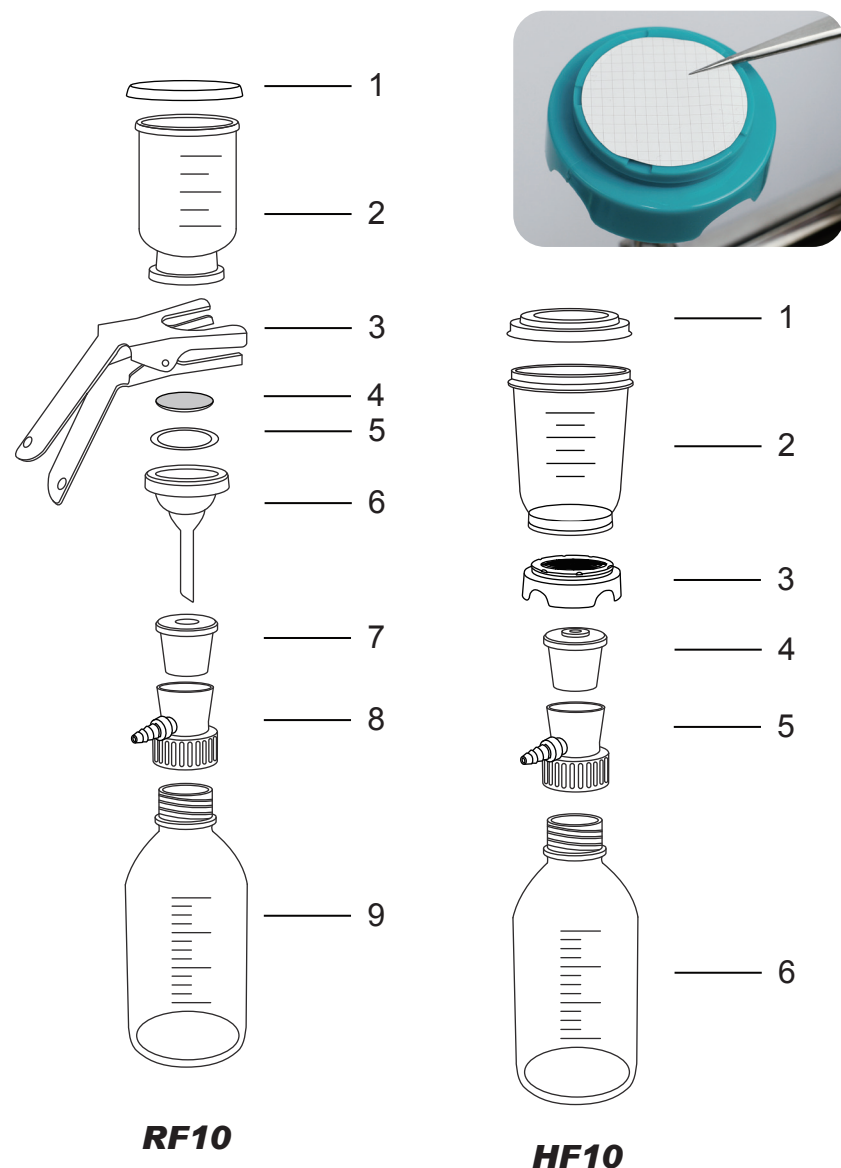

RF10

HF10

RF10

Material	
1 – Funnel lid	Stainless steel
2 – Filter funnel	Borosilicate glass
3 – Clamp	Anodized alum.
4 – Support screen	Stainless steel
5 – Gasket	PTFE
6 – Funnel support base	Borosilicate glass
7 – Silicone stopper	Silicone rubber
8 – Filtration adaptor	PP
9 – Storage bottle	Borosilicate glass
Specification	
Funnel capacity	300ml
Flask capacity	1000ml
Filter diameter	47mm–50 mm
Effective filtration area	9.6cm ²
I.D.tube	6–8mm

HF10

Material	
1 – Funnel lid	PP
2 – Filter funnel	PP
3 – Funnel support base	PP
4 – Silicone stopper	Silicone rubber
with flow tube	Stainless steel
5 – Filtration adaptor	PP
6 – Storage bottle	borosilicate glass
Specification	
Funnel capacity	280ml
Flask capacity	1000ml
Filter diameter	47mm–50 mm
Effective filtration area	9.6cm ²
I.D.tube	6–8mm



Phone: +86 188 2709 1392

Email: chemicals_trading@126.com

Address: Rm 305, Building Tengjundebiyiyuan,
No.1658 Gumei Road, Xuhui District, Shanghai